

Panel and Picture Moulds

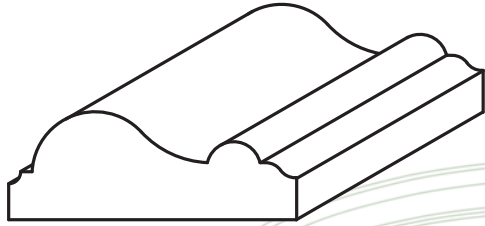

216
 $\frac{1}{16}$ " x 1 $\frac{1}{2}$ "
 OAK, PFJ, WP

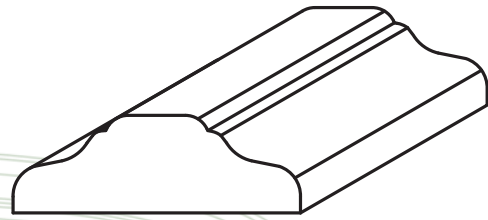

1648
 $\frac{1}{2}$ " x 1 $\frac{1}{2}$ "
 CHE, OAK, POP

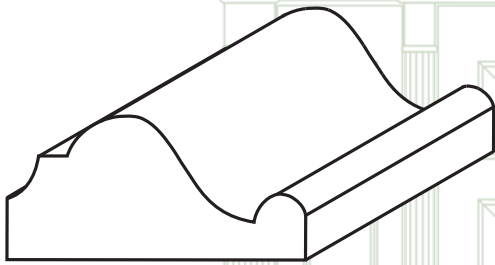

200-PM
 $\frac{3}{4}$ " x 1 $\frac{1}{16}$ "
 OAK, POP

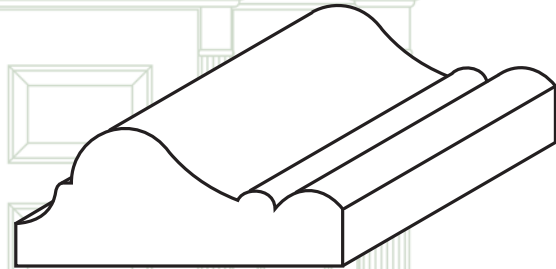

2048-KW-PM
 $\frac{5}{8}$ " x 1 $\frac{1}{2}$ "
 POP

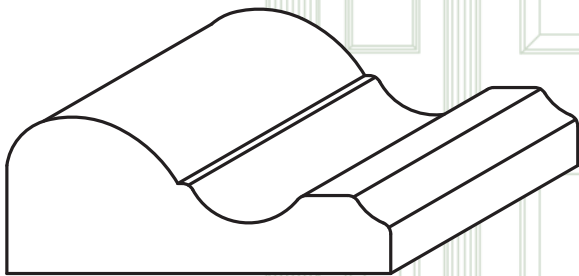

2664-P
 $1\frac{3}{16}$ " x 2"
 CHE, OAK, POP

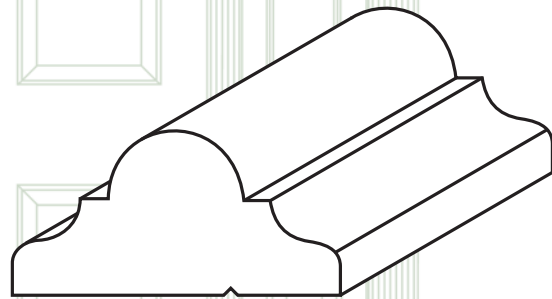

2448-BM
 $\frac{3}{4}$ " x 1 $\frac{1}{2}$ "
 POP, RFJ

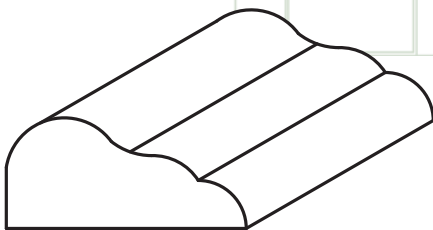

1840
 $\frac{1}{16}$ " x 1 $\frac{1}{4}$ "
 CHE, OAK, POP

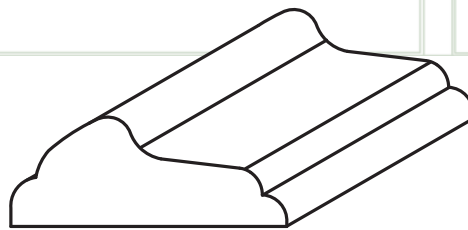

1846
 $\frac{1}{16}$ " x 1 $\frac{7}{16}$ "
 CHE, OAK, POP, RFJ

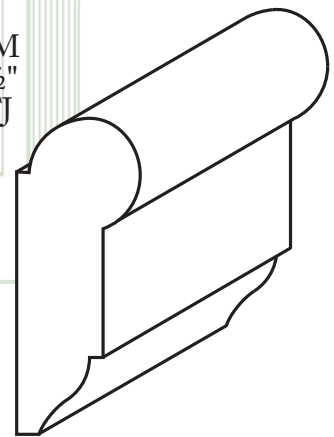

8263
 $\frac{5}{8}$ " x 1 $\frac{3}{4}$ "
 OAK, WP

Notched Panel Moulds

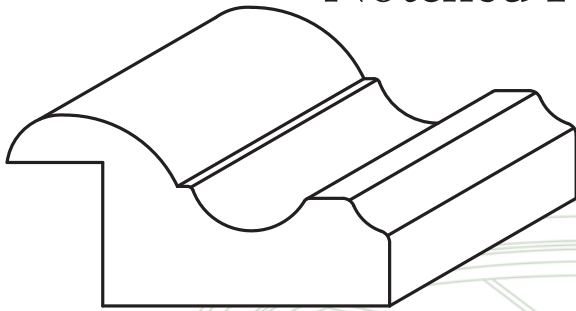

3264-PR
1" x 2"
CHE, OAK, POP, RFJ

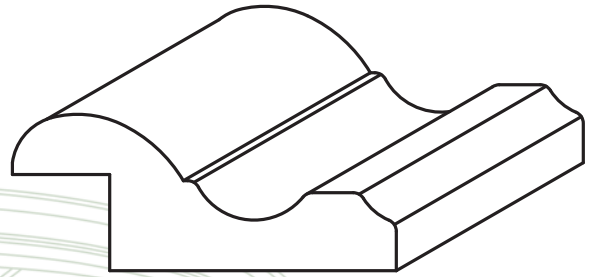

2664-PR
1³/₁₆" x 2"
CHE, OAK, POP

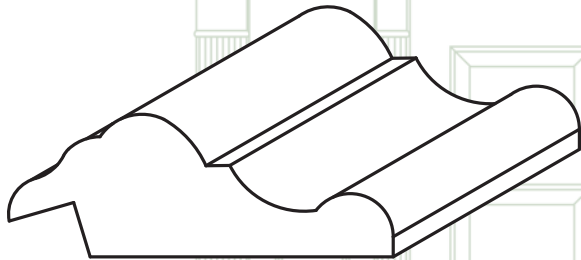

2464-PM
3/4" x 2"
CHE, OAK, POP
Can be positioned
to accomodate a
thickness of 3/16" to 3/4"

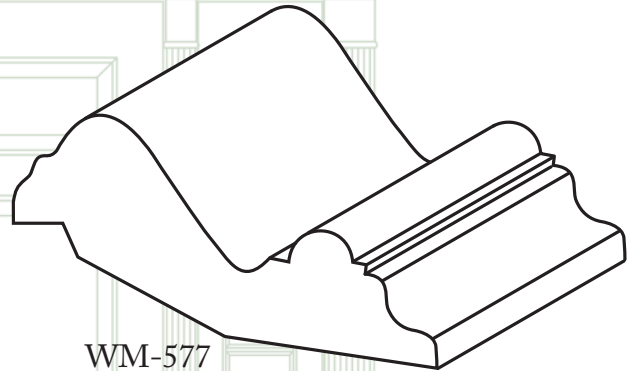

WM-577
3/4" x 2 3/8"
POP

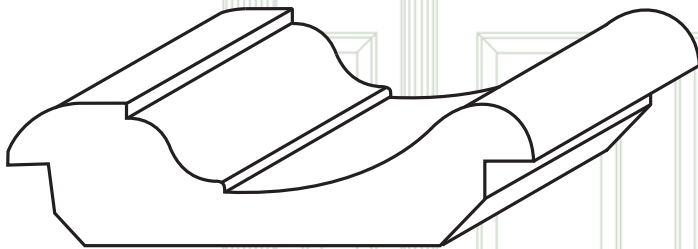

2488-KW-PR
3/4" x 2 3/4"
POP

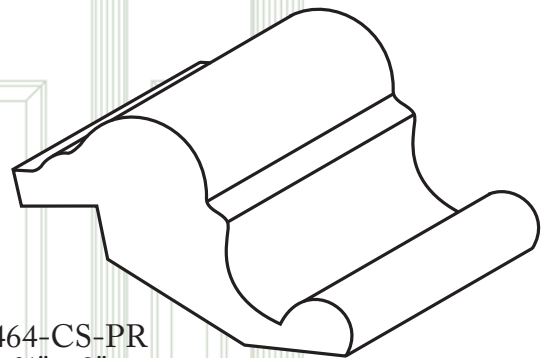

2464-CS-PR
3/4" x 2"
OAK, POP

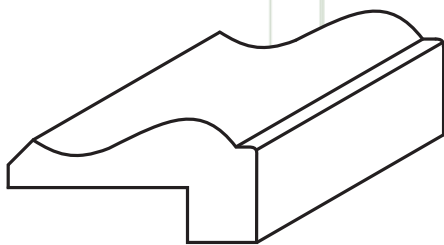

WM-292
9/16" x 1 1/8"
OAK, WP

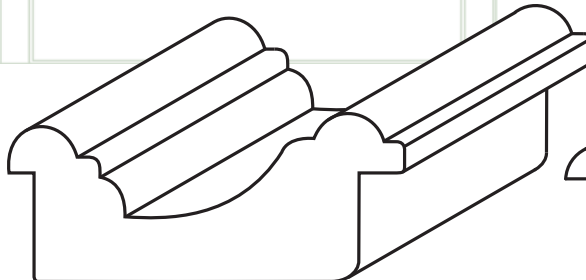

2866-PM
7/8" x 2 1/16"
POP

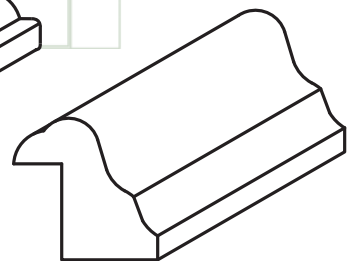

2424-R
3/4" x 3/4"
CHE, OAK, POP